

BG-24230

# 24V 230Ah <sup>LiFePO4</sup>

Lithium Iron Phosphate  
Deep Cycle Battery



### Physical Dimension-mm

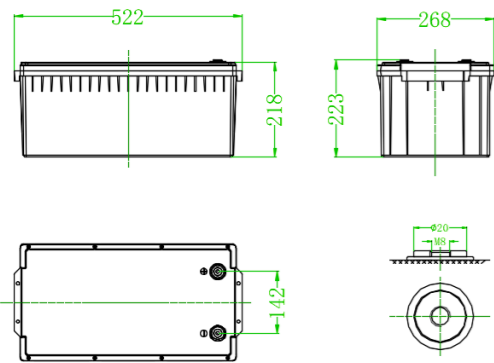

- Lighter Weight**  
About 40% of the weight of a comparable lead acid battery. Easy to replace lead acid batteries.
- Higher Power**  
Delivers twice power of lead acid battery. Higher discharge rate, while maintaining high energy capacity.
- Longer Cycle Life**  
Offers up to 20 times longer cycle life and five times longer float/calendar life than lead acid battery.
- Superior Safety**  
Lithium Iron Phosphate chemistry eliminates the risk of explosion or combustion due to high impact, overcharging or short circuit.

Specification	
Nominal Voltage	25.6V
Nominal Capacity	230Ah / 5888Wh
BMS	Bluetooth with Smartphone App
Cycle Life	>6000 cycles @0.5C / 80%DOD
Months Self Discharge	<3%
Efficiency of Charge	100% @0.5C
Efficiency of Discharge	96~99% @0.5C
Charge Voltage	14.2~14.6V
Charge Mode	0.2C to 14.6V, then change to 0.02C (CC/CV)
Recommended Charge Current	100A
Max. Charge Current	150A
Charge Cut-off Voltage	29.2V±0.2V
Max. Continuous Discharge Current	150A
Peak Discharge Current	450A±160A (0.5-1.5S)
Discharge Cut-off Voltage	21.6V±0.05V
Charge Temperature	0°C~55°C @60±25% Relative Humidity
Discharge Temperature	-20°C~60°C @60±25% Relative Humidity
Storage Temperature	-20°C~45°C @60±25% Relative Humidity
Protection Class	IP65
Approx. Dimensions	523*269*218mm
Approx. Weight	40kg
Terminal	M8
Maximum Modules in Series&Parallel	4
Monitoring Option	Heating and Active equalization

## 24V230AH

BG-24230

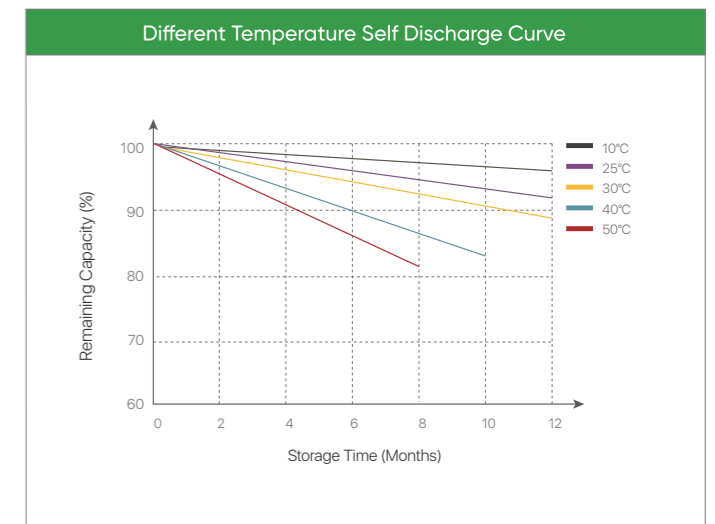
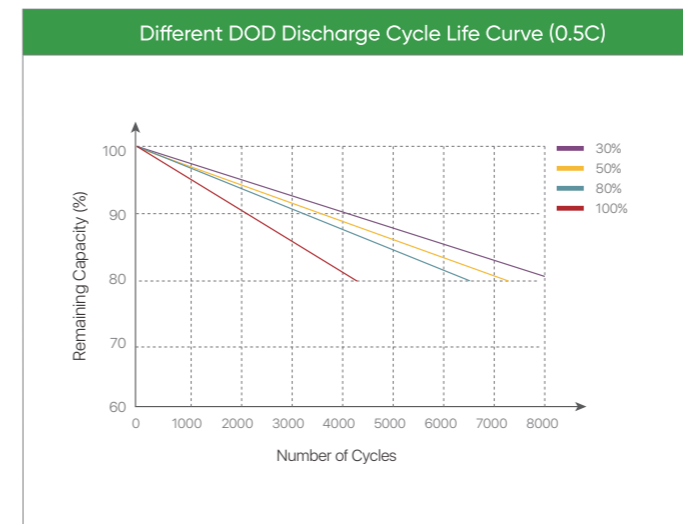
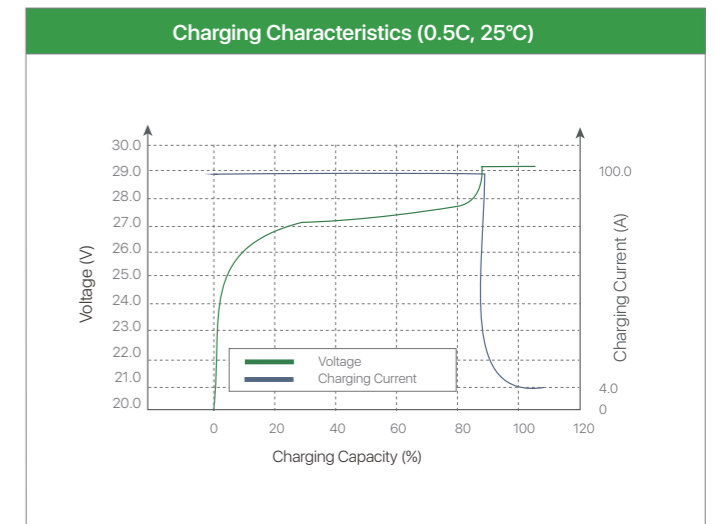
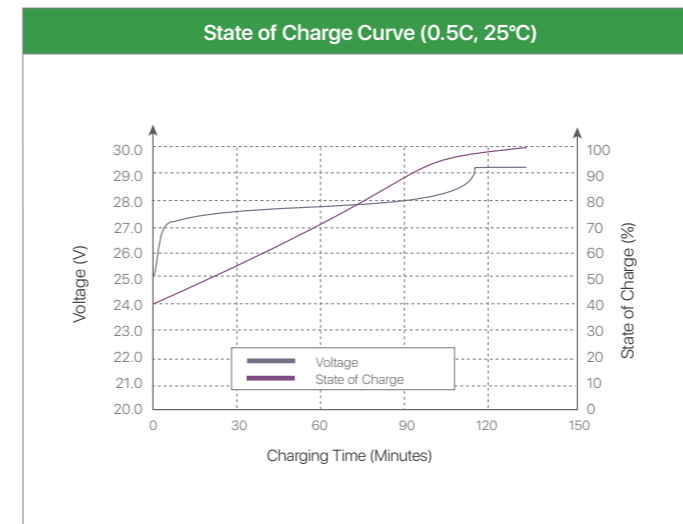
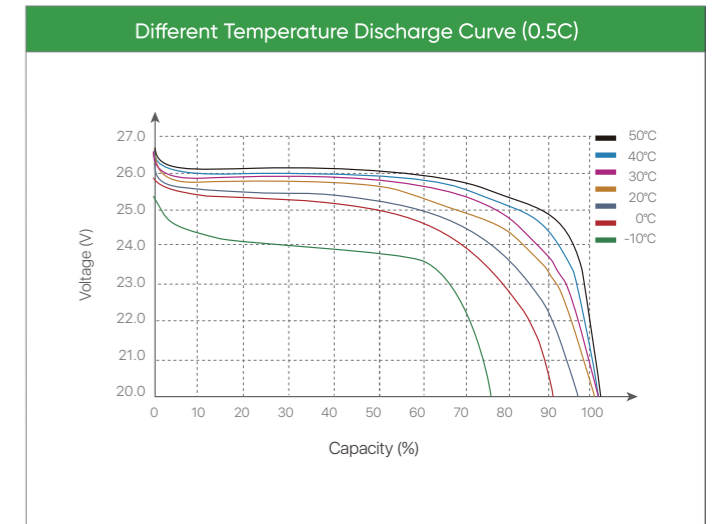
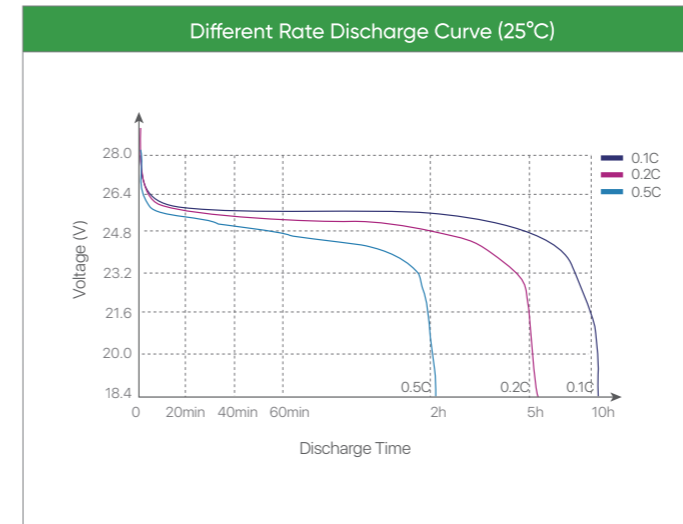

(Note) All above information shall be changed without prior notice, Basen reserves the right to explain and update the latest information.